

- ◇ STRUCTURE Silicon Monolithic Integrated Circuit
- ◇ PRODUCT I²C BUS 8Kbit (1,024 × 8bit) EEPROM
- ◇ PART NUMBER BR24L08-W Series

PART NUMBER	PACKAGE
BR24L08F-W	SOP8
BR24L08FJ-W	SOP-J8
BR24L08FV-W	SSOP-B8
BR24L08FVT-W	TSSOP-B8
BR24L08FVM-W	MSOP8
BR24L08FVJ-W	TSSOP-B8J

- ◇ FEATURES Two wire serial interface
Wide operating voltage range (1.8V~5.5V)
Endurance : 1,000,000 erase/write cycles

◇ ABSOLUTE MAXIMUM RATING (Ta=25°C)

Parameter	Symbol	Rating	Unit
Supply Voltage	V _{cc}	-0.3~6.5	V
Power Dissipation	P _d	450 (BR24L08F-W) *1	mW
		450 (BR24L08FJ-W) *2	
		300 (BR24L08FV-W) *3	
		330 (BR24L08FVT-W) *4	
		310 (BR24L08FVM-W) *5	
		310 (BR24L08FVJ-W) *6	
Storage Temperature	T _{stg}	-65~125	°C
Operating Temperature	T _{opr}	-40~85	°C
Terminal Voltage	—	-0.3~V _{cc} +0.3	V

* Degradation is done at 4.5mW/°C (*1,*2), 3.0mW/°C(*3), 3.3mW/°C(*4), 3.1mW/°C(*5,*6) for operation above 25°C.

◇ RECOMMENDED OPERATING CONDITION

Parameter	Symbol	Rating	Unit
Supply Voltage	V _{cc}	1.8~5.5	V
Input Voltage	V _{IN}	0~V _{cc}	V

Status of this document

The Japanese version of this document is the formal specification.

A customer may use this translation version only for a reference to help reading the formal version.

If there are any differences in translation version of this document, formal version takes priority.

◇ MEMORY CELL CHARACTERISTICS(Ta=25°C, Vcc=1.8~5.5V)

Parameter	Specification	Unit		
			Min.	Typ.
Writes/Erase Cycle *1	1,000,000	-	-	Cycles
Data Retention *1	40	-	-	Years

○Initial Data FFh in all address. *1 Not 100% TESTED

◇ DC OPERATING CHARACTERISTICS
(Unless otherwise specified Ta=-40~85°C, Vcc=1.8~5.5V)

Parameter	Symbol	Specification			Unit	Test Condition
		Min.	Typ.	Max.		
"H" Input Voltage1	VIH1	0.7Vcc	-	-	V	2.5V ≤ Vcc ≤ 5.5V
"L" Input Voltage1	VIL1	-	-	0.3Vcc	V	2.5V ≤ Vcc ≤ 5.5V
"H" Input Voltage2	VIH2	0.8Vcc	-	-	V	1.8V ≤ Vcc < 2.5V
"L" Input Voltage2	VIL2	-	-	0.2Vcc	V	1.8V ≤ Vcc < 2.5V
"L" Output Voltage1	VOL1	-	-	0.4	V	IOL=3.0mA, 2.5V ≤ Vcc ≤ 5.5V (SDA)
"L" Output Voltage2	VOL2	-	-	0.2	V	IOL=0.7mA, 1.8V ≤ Vcc < 2.5V (SDA)
Input Leakage Current	ILI	-1	-	1	μA	VIN=0V~Vcc
Output Leakage Current	ILO	-1	-	1	μA	VOUT=0V~Vcc (SDA)
Operating Current	ICC1	-	-	2.0	mA	Vcc=5.5V, fSCL=400kHz, tWR=5ms Byte Write, Page Write
	ICC2	-	-	0.5	mA	Vcc=5.5V, fSCL=400kHz Random Read, Current Read, Sequential Read
Standby Current	ISB	-	-	2.0	μA	Vcc=5.5V, SDA, SCL=Vcc A0, A1, A2=GND, WP=GND

○This product is not designed for protection against radioactive rays.

◇ AC OPERATING CHARACTERISTICS
(Unless otherwise specified Ta=-40~85°C, Vcc=1.8~5.5V)

Parameter	Symbol	FAST-MODE			STANDARD-MODE			Unit
		2.5V ≤ Vcc ≤ 5.5V			1.8V ≤ Vcc ≤ 5.5V			
		Min.	Typ.	Max.	Min.	Typ.	Max.	
Clock Frequency	fSCL	-	-	400	-	-	100	kHz
Data Clock High Period	tHIGH	0.6	-	-	4.0	-	-	μs
Data Clock Low Period	tLOW	1.2	-	-	4.7	-	-	μs
SDA and SCL Rise Time *1	tR	-	-	0.3	-	-	1.0	μs
SDA and SCL Fall Time *1	tF	-	-	0.3	-	-	0.3	μs
Start Condition Hold Time	tHD:STA	0.6	-	-	4.0	-	-	μs
Start Condition Setup Time	tSU:STA	0.6	-	-	4.7	-	-	μs
Input Data Hold Time	tHD:DAT	0	-	-	0	-	-	ns
Input Data Setup Time	tSU:DAT	100	-	-	250	-	-	ns
Output Data Delay Time	tPD	0.1	-	0.9	0.2	-	3.5	μs
Output Data Hold Time	tDH	0.1	-	-	0.2	-	-	μs
Stop Condition Setup Time	tSU:STO	0.6	-	-	4.7	-	-	μs
Bus Free Time	tBUF	1.2	-	-	4.7	-	-	μs
Write Cycle Time	tWR	-	-	5	-	-	5	ms
Noise Spike Width (SDA and SCL)	tI	-	-	0.1	-	-	0.1	μs
WP Hold Time	tHD:WP	0	-	-	0	-	-	ns
WP Setup Time	tSU:WP	0.1	-	-	0.1	-	-	μs
WP High Period	tHIGH:WP	1.0	-	-	1.0	-	-	μs

*1 Not 100% TESTED

◇ BLOCK DIAGRAM

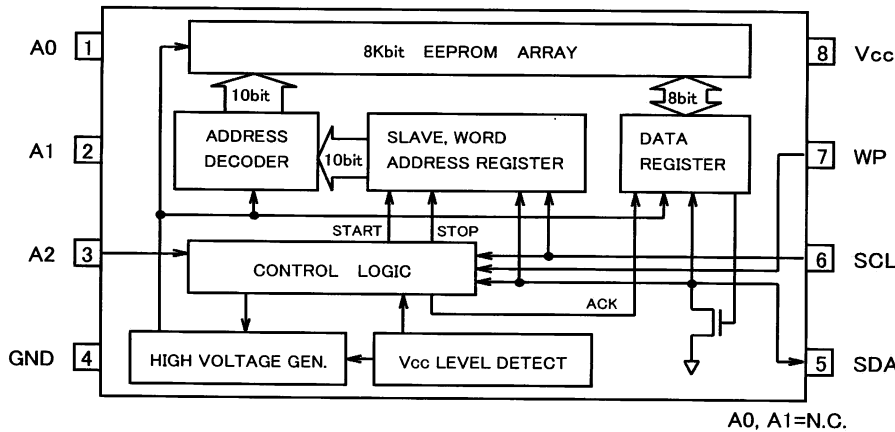

◇ PIN No., PIN NAME

PIN No.	PIN NAME
1	A0
2	A1
3	A2
4	GND
5	SDA
6	SCL
7	WP
8	Vcc

Fig.-1 BLOCK DIAGRAM

◇ NOTES FOR POWER SUPPLY

Vcc rises through the low voltage region in which internal circuit of IC and the controller are unstable, so that device may not work properly due to an incomplete reset of internal circuit. To prevent this, the device has the feature of P.O.R. and LVCC. In the case of power up, keep the following conditions to ensure functions of P.O.R. and LVCC.

1. It is necessary to be "SDA='H'" and "SCL='L' or 'H'".
2. Follow the recommended conditions of tR, tOFF, Vbot for the function of P.O.R. during power up.

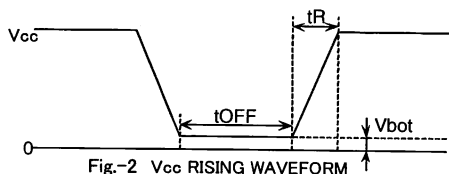

◇ RECOMMENDED CONDITIONS OF tR, tOFF, Vbot

tR	tOFF	Vbot
Below 10ms	Above 10ms	Below 0.3V
Below 100ms	Above 10ms	Below 0.2V

3. Prevent SDA and SCL from being "High-Z".

In case that condition 1. and/or 2. cannot be met, take following actions.

- A) Unable to keep condition 1.
(SDA is "LOW" during power up.)
→ Control SDA ,SCL to be "HIGH" as Fig.-3(a), 3(b).
- B) Unable to keep condition 2.
→ After power becomes stable, execute software reset.
- C) Unable to keep both conditions 1 and 2.
→ Follow the instruction A first, then the instruction B.

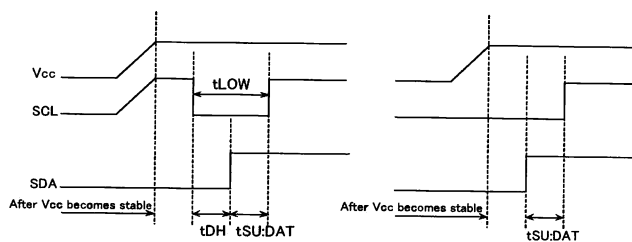

Fig.-3(a) SCL='H' and SDA='L'

Fig.-3(b) SCL='L' and SDA='L'

◇ CAUTIONS ON USE

- (1) Absolute maximum ratings

If the absolute maximum ratings such as impressed voltage and action temperature range and so forth are exceeded, LSI may be destructed. Do not impress voltage and temperature exceeding the absolute maximum ratings. In the case of fear exceeding the absolute maximum ratings, take physical safety countermeasures such as fuses, and see to it that conditions exceeding the absolute maximum ratings should not be impressed to LSI.

- (2) GND electric potential

Set the voltage of GND terminal lowest at any action condition. Make sure that each terminal voltage is lower than that of GND terminal.

- (3) Thermal design

In consideration of permissible loss in actual use condition, carry out heat design with sufficient margin.

- (4) Terminal to terminal shortcircuit and wrong packaging

When to package LSI onto a board, pay sufficient attention to LSI direction and displacement. Wrong packaging may destruct LSI. And in the case of shortcircuit between LSI terminals and terminals and power source, terminal and GND owing to foreign matter, LSI may be destructed.

- (5) Use in a strong electromagnetic field may cause malfunction, therefore, evaluated design sufficiently.

◇PHYSICAL DIMENSION

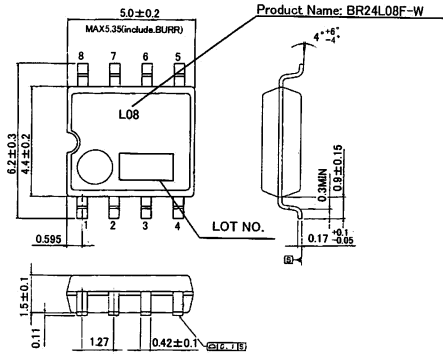

Fig.-4(a) PHYSICAL DIMENSION
SOP8 (BR24L08F-W)

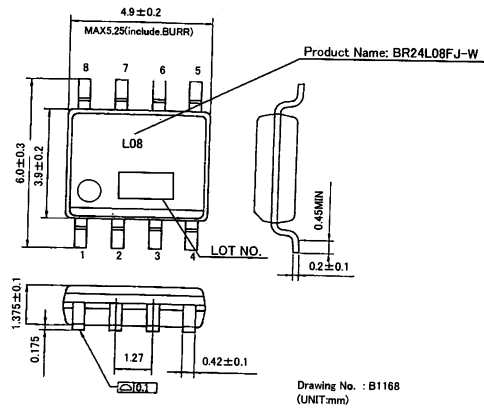

Fig.-4(b) PHYSICAL DIMENSION
SOP-J8 (BR24L08FJ-W)

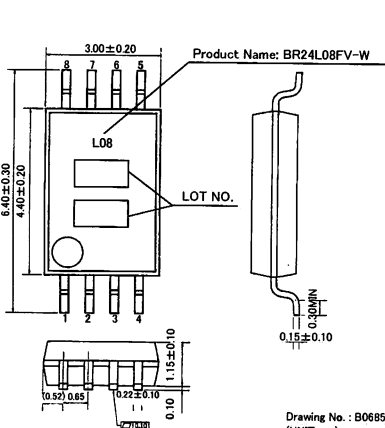

Fig.-4(c) PHYSICAL DIMENSION
SSOP-B8 (BR24L08FV-W)

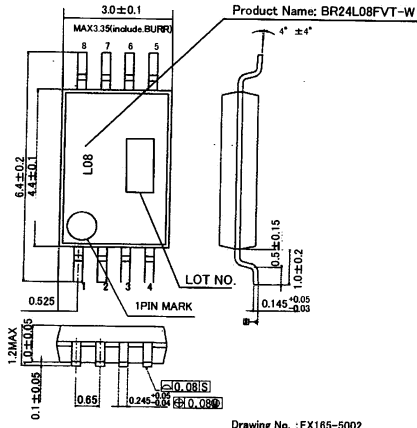

Fig.-4(d) PHYSICAL DIMENSION
TSSOP-B8 (BR24L08FVT-W)

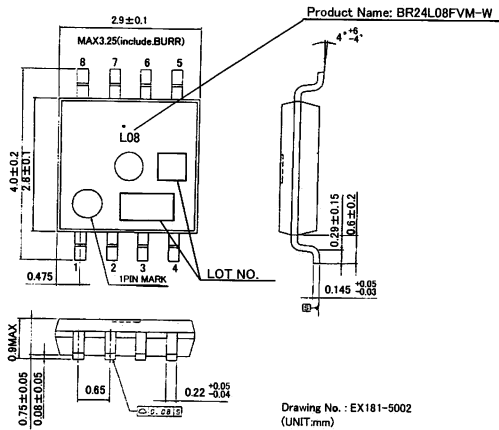

Fig.-4(e) PHYSICAL DIMENSION
MSOP8 (BR24L08FVM-W)

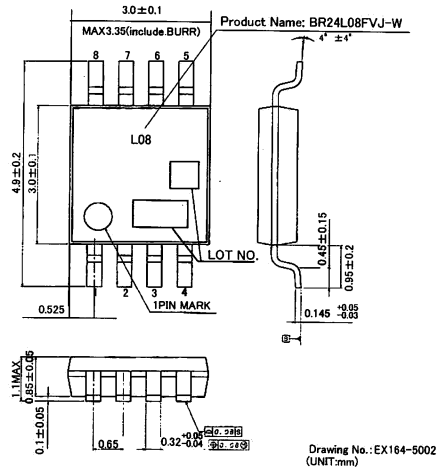

Fig.-4(f) PHYSICAL DIMENSION
TSSOP-B8J (BR24L08FVJ-W)

Notes

- No technical content pages of this document may be reproduced in any form or transmitted by any means without prior permission of ROHM CO.,LTD.
- The contents described herein are subject to change without notice. The specifications for the product described in this document are for reference only. Upon actual use, therefore, please request that specifications to be separately delivered.
- Application circuit diagrams and circuit constants contained herein are shown as examples of standard use and operation. Please pay careful attention to the peripheral conditions when designing circuits and deciding upon circuit constants in the set.
- Any data, including, but not limited to application circuit diagrams information, described herein are intended only as illustrations of such devices and not as the specifications for such devices. ROHM CO.,LTD. disclaims any warranty that any use of such devices shall be free from infringement of any third party's intellectual property rights or other proprietary rights, and further, assumes no liability of whatsoever nature in the event of any such infringement, or arising from or connected with or related to the use of such devices.
- Upon the sale of any such devices, other than for buyer's right to use such devices itself, resell or otherwise dispose of the same, no express or implied right or license to practice or commercially exploit any intellectual property rights or other proprietary rights owned or controlled by
- ROHM CO., LTD. is granted to any such buyer.
- Products listed in this document are no antiradiation design.

The products listed in this document are designed to be used with ordinary electronic equipment or devices (such as audio visual equipment, office-automation equipment, communications devices, electrical appliances and electronic toys).

Should you intend to use these products with equipment or devices which require an extremely high level of reliability and the malfunction of which would directly endanger human life (such as medical instruments, transportation equipment, aerospace machinery, nuclear-reactor controllers, fuel controllers and other safety devices), please be sure to consult with our sales representative in advance.

About Export Control Order in Japan

Products described herein are the objects of controlled goods in Annex 1 (Item 16) of Export Trade Control Order in Japan.

In case of export from Japan, please confirm if it applies to "objective" criteria or an "informed" (by MITI clause) on the basis of "catch all controls for Non-Proliferation of Weapons of Mass Destruction.

Thank you for your accessing to ROHM product informations.
More detail product informations and catalogs are available,
please contact your nearest sales office.

Please contact our sales offices for details ;

U.S.A / San Diego	TEL : +1(858)625-3630	FAX : +1(858)625-3670
Atlanta	TEL : +1(770)754-5972	FAX : +1(770)754-0691
Dallas	TEL : +1(972)312-8818	FAX : +1(972)312-0330
Germany / Dusseldorf	TEL : +49(2154)9210	FAX : +49(2154)921400
United Kingdom / London	TEL : +44(1)908-282-666	FAX : +44(1)908-282-528
France / Paris	TEL : +33(0)1 56 97 30 60	FAX : +33(0) 1 56 97 30 80
China / Hong Kong	TEL : +852(2)740-6262	FAX : +852(2)375-8971
Shanghai	TEL : +86(21)6279-2727	FAX : +86(21)6247-2066
Dilian	TEL : +86(411)8230-8549	FAX : +86(411)8230-8537
Beijing	TEL : +86(10)8525-2483	FAX : +86(10)8525-2489
Taiwan / Taipei	TEL : +866(2)2500-6956	FAX : +866(2)2503-2869
Korea / Seoul	TEL : +82(2)8182-700	FAX : +82(2)8182-715
Singapore	TEL : +65-6332-2322	FAX : +65-6332-5662
Malaysia / Kuala Lumpur	TEL : +60(3)7958-8355	FAX : +60(3)7958-8377
Philippines / Manila	TEL : +63(2)807-6872	FAX : +63(2)809-1422
Thailand / Bangkok	TEL : +66(2)254-4890	FAX : +66(2)256-6334

Japan /
(Internal Sales)

Tokyo	2-1-1, Yaesu, Chuo-ku, Tokyo 104-0082	TEL : +81(3)5203-0321	FAX : +81(3)5203-0300
Yokohama	2-4-8, Shin Yokohama, Kohoku-ku, Yokohama, Kanagawa 222-8575	TEL : +81(45)476-2131	FAX : +81(45)476-2128
Nagoya	Dainagayo Building 9F 3-28-12, Meieki, Nakamura-ku, Nagoya, Aichi 450-0002	TEL : +81(52)581-8521	FAX : +81(52)561-2173
Kyoto	579-32 Higashi Shiokouji-cho, Karasuma Nishi-iru, Shiokoujidori, Shimogyo-ku, Kyoto 600-8216	TEL : +81(75)311-2121	FAX : +81(75)314-6559

(Contact address for overseas customers in Japan)

Yokohama	TEL : +81(45)476-9270	FAX : +81(045)476-9271
----------	-----------------------	------------------------